

STEEL SHELVING INSTRUCTION SHEET

CAUTION

IT IS THE RESPONSIBILITY OF THE PERSON ASSEMBLING THE SHELVING TO PROPERLY INSTALL ALL COMPONENTS AND HARDWARE AS SPECIFIED IN THESE INSTRUCTIONS AND ANY ACCOMPANYING DRAWINGS FOR SPECIFIC INSTALLATION.

- *INSTALL ALL REQUIRED SIDE AND BACK SWAY BRACES*
- *INSTALL FOOT PLATES AND SHIMS IF REQUIRED*
- *INSTALL ALL UNITS PLUMB*
- *TIGHTEN ALL HARDWARE SECURELY*

GENERAL INSTRUCTIONS

- 1. These instructions are for the person who will actually supervise the assembly of the equipment covered by your order. -- Please see that they get them --*
- 2. Check material received against the packing list. First check the number of packages received and then check the contents of each package.*
- 3. Check material received for damage. If damaged, secure a "damage notation" from the carrier.*
- 4. Identify each part as it is unpacked and pile like parts together and as close as possible to the working area in which they are to be assembled.*
- 5. Lay out on the floor the space that each rack of shelving is to occupy and build each rack in its proper location.*
- 6. Be careful to use the correct hardware as specified in the assembly instructions.*
- 7. Make sure units are plumb before tightening sway braces and/or back panel bolts.*

HARDWARE SCHEDULE

<i>ITEM</i>	<i>Nuts & Bolts 1/4-20 x 1/2" lg.</i>	<i>Nuts & Bolts 1/4-20 x 1 1/4" lg.</i>	<i>Back Panel Clips Part No. 5120</i>	<i>Spring Clips Part No. 5260</i>
<i>Back Panels 3' 3"</i>	6		3	
<i>Back Panels 6' 3"</i>	8		4	
<i>Back Panels 7' 3" and 8' 3"</i>	10		4	
<i>Back Panels 10' 3"</i>	12		5	
<i>Shelf Reinforcing Channels</i>	3			
<i>Bin Fronts</i>		3		
<i>Base Strips</i>	3			
<i>Full Dividers (up to 18" deep)</i>				4
<i>Full Dividers (24" deep)</i>				6
<i>Partial Dividers (up to 18" deep)</i>				2
<i>Partial Dividers (24" deep)</i>				3
<i>Label Holders</i>				3
<i>Back Sway Braces</i>	5			
<i>Side Sway Brace</i>	5			

NOTE: All bolts are Truss Head type with hex type nuts.

PARTS BREAK-OUT

Shelf
Part No. 5138 & 39

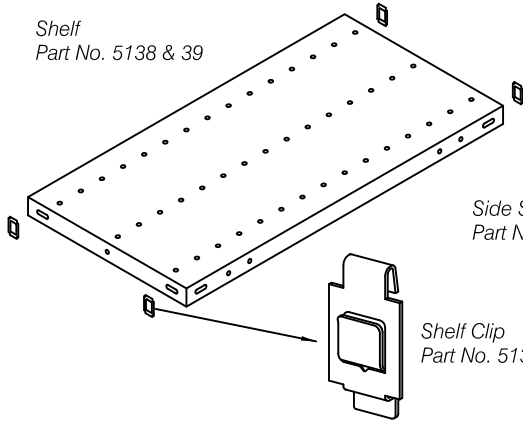

Shelf Clip
Part No. 5133

Side Sway Brace
Part No. 5344

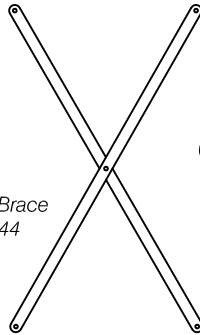

Foot Plates
Part No. 5050

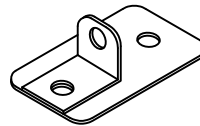

T-Post for
Adjoining
Sections
Part No. 5006

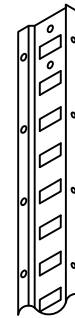

Back Post
Part No. 5004



Beaded
Front Post
Part No. 5002

Back Panel
Part No. 5111

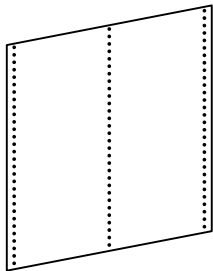

Back Panel Clip
Part No. 5120

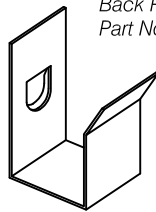

End Sections For Closed Type Shelving
"T" Panel
Part No. 5094
End Panel
Part No. 5092

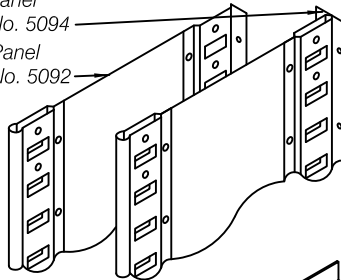

Label Holder
Part No. 5370

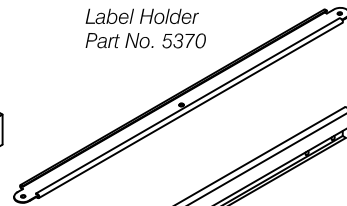

Side Panel
Part No. 5096

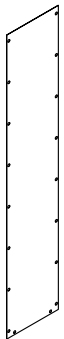

Class III
Shelf Support
Part No. 5136

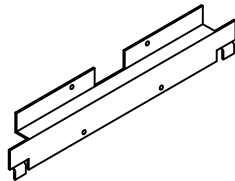

Base Strip
Part No. 5233

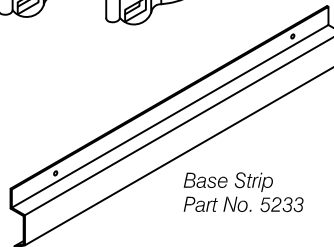

Bin Front
Part No. 5220

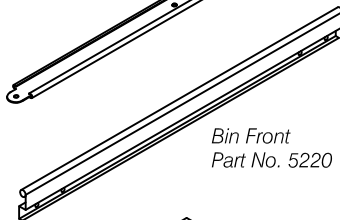

Class III
Center Support
Hat Section
Part No. 5137

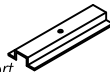

Class III
Bottom
Part No. 5131

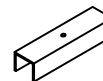

Splice Channel
Part No. 5009

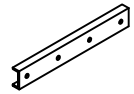

Spring Clip
Part No. 5260



Full Divider
Part No. 5240

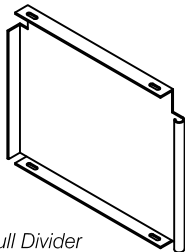

Back Sway Brace
Part No. 5342

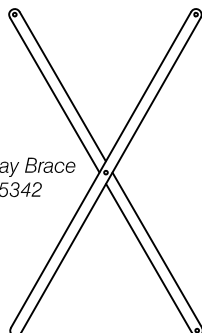

Partial Divider
Part No. 5250

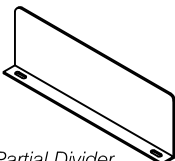

HALLOWELL HI-TECH, CLIP SHELVING



CLASS 0

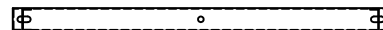

CLASS I

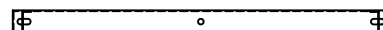

CLASS II



CLASS III EXCEPT FOR BOTTOM SHELF

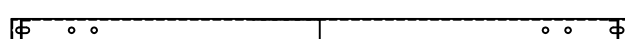

CLASS III BOTTOM SHELF ONLY

CLOSED TYPE SHELVING

END PANEL AND "T" PANEL ASSEMBLY

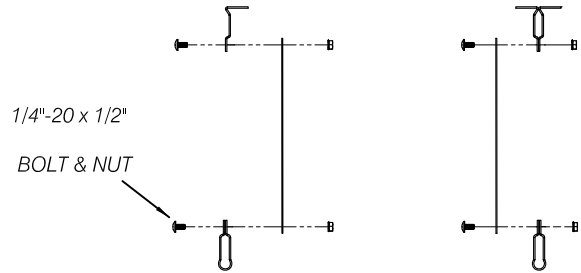
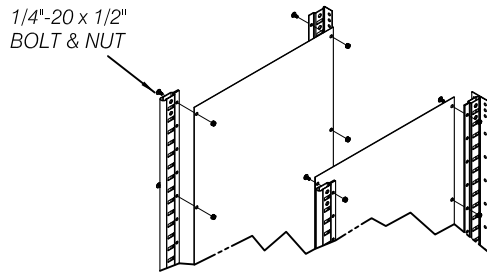

INDIVIDUAL UNITS - 3' 3" TO 10' 3" HEIGHTS

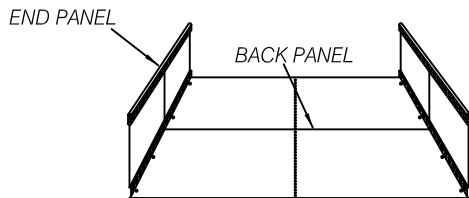

FIGURE 1

STEP 1. END PANELS TO BACK PANEL

Use two end panels. Start with assembly in horizontal position, back panel flat on floor, bench or trestles.

Slide inside of back posts on end panel flat on floor, bench or trestles. Slide inside of back post on end panel under back panel and bolt. (Figure 1 & 1A)

NOTE: Units 3' 3" or greater in height require multiple back panels which overlap.

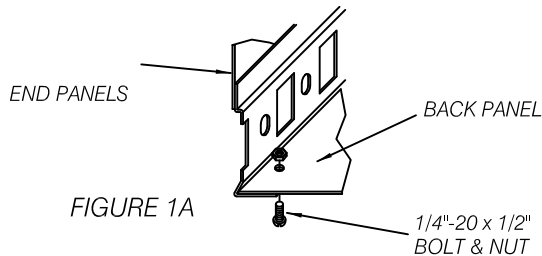

FIGURE 1A

BACK TO BACK UNITS

Hook shelf clips into indentation at top of front & rear post, and hook back panel clip through top center hole in back panel. Position top shelf with rear flange on back panel clip and hook end flanges of shelf on shelf clips.

Then wedge in lock position.

STARTING, ADJOINING and BACK to BACK UNITS

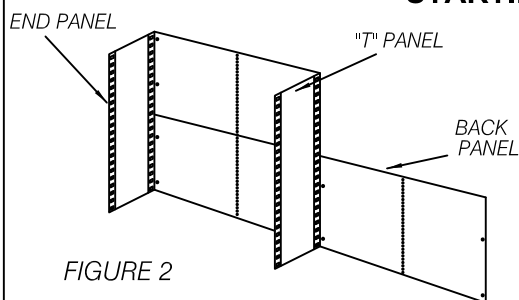

FIGURE 2

Use one end panel and one "T" panel for starting unit. Position lower back panel inside back post of end panel and bolt.

BACK TO BACK UNITS

Use two end panels in an upright position, back to back. Slide lower back panel between rear flanges of end panels and bolt (Figure 3).

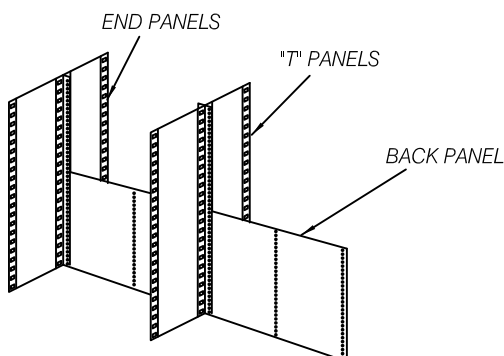

FIGURE 3

Leave top holes of lower back panel unbolted; add "T" panels and lower back panels until rack of sides and backs are completely assembled.

- Add bottom shelves (as in Step 4) and shelf near center of units (as in Step 5).
- Add top half of back panels to rack, in same manner as lower half and bolt.
- Add top shelves to rack as in Step 2.
- Add necessary intermediate shelves as in Step 5.

CLOSED TYPE SHELVING

STEP 2.

TOP SHELF (See Step 2 for Individual Units)

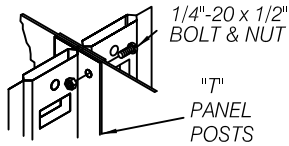

FIGURE 3A

STEP 3. ACCESSORIES

Insert Class III shelf support (if required) in shelves. Add bin are not necessary for the top shelf. Spring clips are normally

STEP 4. BOTTOM SHELF (All Units)

Bolt base strip to bottom shelf. (Figure 4). Hook shelf clips into second rectangular slots from bottom of post. Hook back panel to back units.

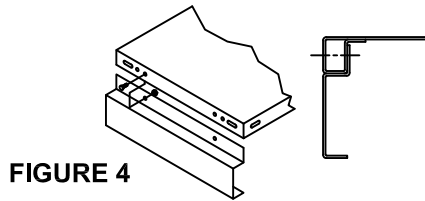

FIGURE 4

Position bottom shelf over back panel clip with end flanges hooked on shelf clips and wedge down.

STEP 5. ADDING REMAINING SHELVES

Hook shelf clips to panels (Figure 6A), position shelves with end flanges hooked on shelf clips and wedge shelves down in locked position as shown (Figure 6). Back panel clips should be used to secure back panel to shelves, except on back to back shelving. (Figure 7)

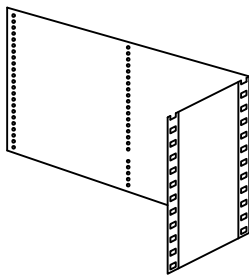

FIGURE 5

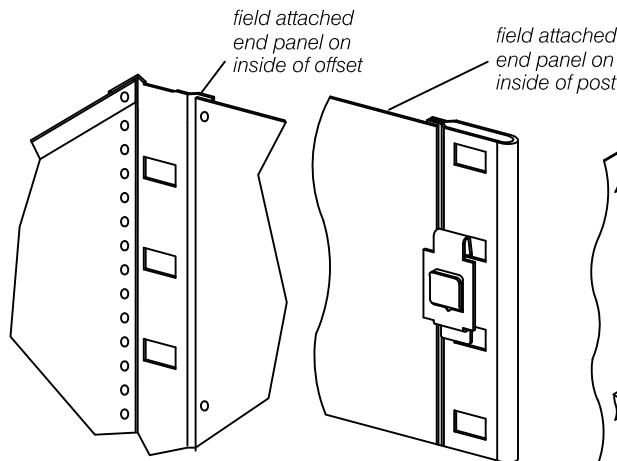

FIGURE 6B

FIGURE 6A

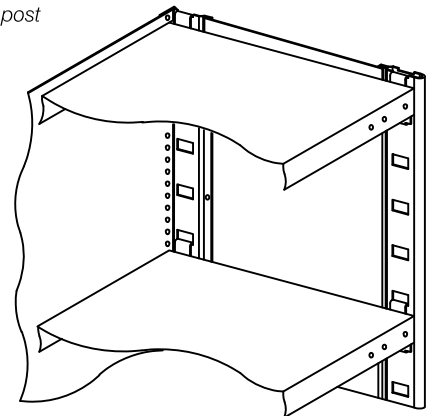

FIGURE 6

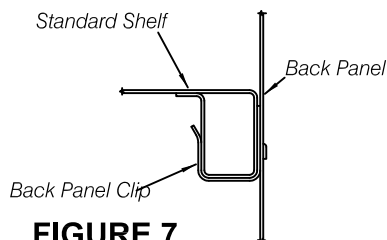

FIGURE 7

OPEN TYPE SHELVING

SIDE PANEL SWAY BRACE

POST HEIGHT	SHELF DEPTH	"A"	"B"
3' - 3"	12	9"	21"
	15	7 1/2"	24"
	18	6"	27"
	24	6"	27"
	30	6"	27"
6' - 3"	12	27"	21"
	15	25 1/2"	24"
	18	24"	27"
	24	24"	27"
	30	24"	27"
7' - 3"	12	33"	21"
	15	31 1/2"	24"
	18	30"	27"
	24	30"	27"
	30	30"	27"
8' - 3"*	12	24"	21"
	15	21"	24"
	18	18"	27"
	24	18"	27"
	30	18"	27"
10' - 3"*	12	31 1/2"	21"
	15	28 1/2"	24"
	18	25 1/2"	27"
	24	25 1/2"	27"
	30	25 1/2"	27"
36	25 1/2"	27"	

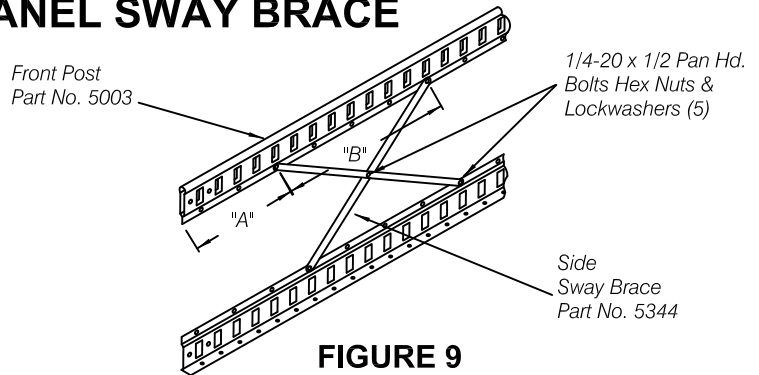

FIGURE 9

Fasten side sway braces to front and back posts of the open section, maintaining dimension "A" according to the length of the post.

NOTE: If finished end panels are to be used, be sure to place side sway braces on inside of post with bolt head on outside of post.

INDIVIDUAL UNIT

Use two beaded posts for front and two back posts.

STARTING UNIT

Use two beaded posts for front, one back post, and one rear "T" post.

BACK TO BACK

For individual back to back units use four post assemblies with back posts. For starting back to back units use two post assemblies with back post and two with rear "T" posts.

* These heights require two pair of sway braces. Hold 'A' from each end of post.

TOP AND BOTTOM SHELF

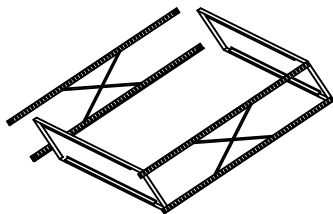

FIGURE 10

A. HI-TECH SHELVING

Place shelf clips into second rectangular slot from bottom of posts, and into the indentation at top. Now add the top and bottom shelves to post and sway brace assemblies. (Figure 10)

LOCATING BACK SWAY BRACES

Back sway braces are the cross strap type. They must be bolted to the back posts at 4 points and where they cross in the center. Use five 1/4"-20 x 1/2" pan hd. bolts and nuts per pair of braces.

INDIVIDUAL UNITS

Starting and/or inserting shelves at top and bottom as per step 5. Stand in upright position and add back sway braces as shown in Figure 11.

BACK TO BACK UNITS

Assemble ununits as described above. Stand starting sections in an upright position. Place units back to back. Insert back sway braces between rear posts as shown in Figure 13 and bolt through posts, connecting units together as shown in Figure 12.

NOTE: For 8'-3" & 10'-3" high units, use 2 sets of sway braces.

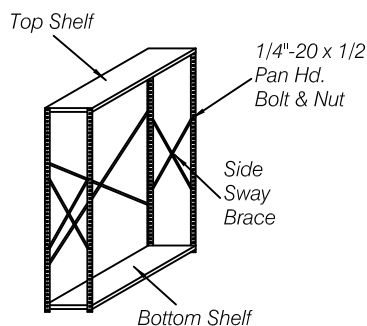

FIGURE 11

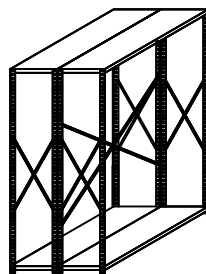

FIGURE 12

OPEN TYPE SHELVING

ADDING ADJOINING UNITS

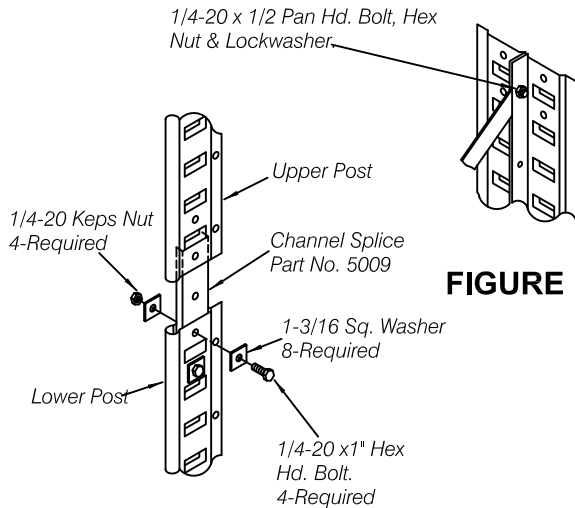

FIGURE 13

FIGURE 14

Hook shelf clips into second rectangular slot from the bottom of the starting unit and into indentation at the top of the post assembly. Preassemble a beaded post-rear "T" post combination (two required for an adjoining back to back unit) with shelf clips. Add top and bottom shelves, using them to hold new post combination in place while the sway braces are secured to the back posts. Add intermediate shelves as required per Step 5.

"Beaded Front Post and Tee Post"

1. Insert channel in lower front post and tee post and bolt with, (2) 1/4"-20 x 1" hex head bolts, (4) square washers and (2) 1/4"-20 keps nuts, through oval slots in end of posts. Figure 13.
2. Place upper post over extended splice channel and bolt through oval slots as in step 1 above. Figure 13.

"Back Post"

1. Place splice channel on outside of post and bolt as above except square washers are not required on exposed splice channel.

SWINGING DOOR ASSEMBLY INSTRUCTIONS

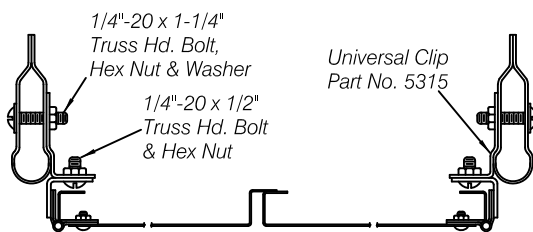

FIGURE 15

- Step 1: Remove three items from carton. Door and frame assembly, lock bars and hardware kit.
- Step 2: Read all information on assembly instruction and familiarize yourself with all component names.
- Step 3: Bolt universal clips to post with 1/4-20 x 1-1/4" truss head bolts and hex nuts. Use four universal clips on 36" and 48" door and frame, and use six universal clips on 73" and 85" door frame. Bolt door and frame to universal clips with two 1/4-20 x 1/2" truss head bolts and hex nuts.
- Step 4: Assemble handle and other locking mechanism to door per handle instructions. Keep door handle on R.H. door.

HANDLE ASSEMBLY INSTRUCTIONS

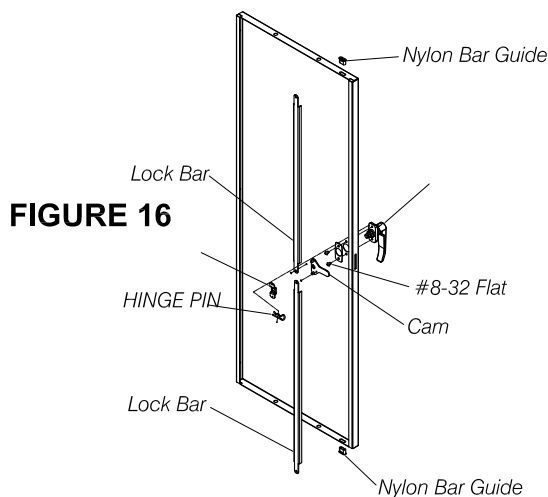
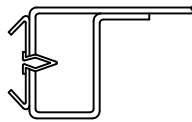

FIGURE 16

- Step 1: Attach handle to the right hand door with the two screws #8-32 bolts.
- Step 2: Install the nylon bar guides in top and bottom door slots.
- Step 3: With right hand door laying down, place lock cam thru slot in door and over handle with pins out. Insert lock rods into lock rod guides and position holes in lock rods on pins of lock cam. Secure in place with cam keeper using #8-32 flat head screw.

SHELVING ACCESSORIES

FIGURE 17



1. Label Holders

Label holders are attached to front flange of shelf with spring clips. Place label holder against front flange of shelf and push spring clip thru holes in shelf (Figure 17).

FIGURE 18

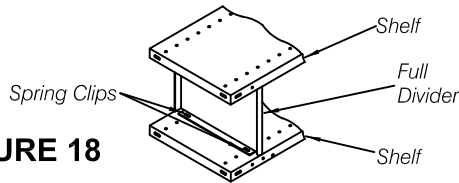

2. Full Dividers

Any shelf opening may be divided into two or more bins by the installation of full dividers. To install dividers, place them in position between the shelves where required and align slots in flanges of the dividers with holes in shelves. Attach dividers to shelves with spring clips as in (Figure 18).

FIGURE 19

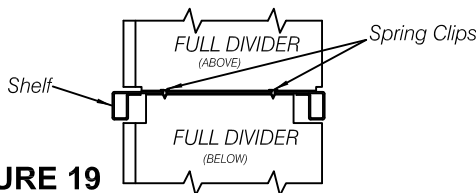

Where dividers are above and below a shelf and in alignment, use common spring clips to attach the two dividers, as in Figure 19.

Dividers may also be bolted to shelves by customer but only spring clips are furnished as hardware.

FIGURE 20

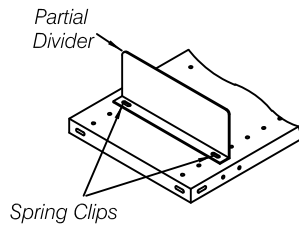

3. Partial Dividers

Partial dividers are attached to shelves where required as illustrated, with spring clips (Figure 20).

Partial dividers may also be bolted to shelves, but only spring clips are furnished as hardware.

FIGURE 21

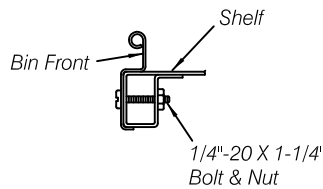

4. Offset Bin Front

Bin fronts are attached to front flange of shelf with 1/4"-20 x 1-1/4 pan hd. bolts and nuts.

Place bin front against front flange of shelf as shown and bolt thru holes in bin front and shelf (Figure 21).

FIGURE 22

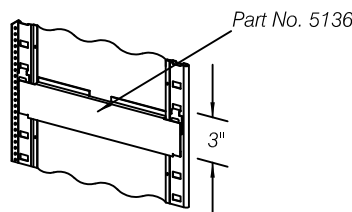

5. Class II Shelf Support

A Class 3 shelf support is used for class 3 shelf classification. Position support into second rectangular slots directly below required shelf position as shown in (Figure 22).

Insert top shelf clip into second rectangular slot above Class 3 shelf support. Now place shelf with reinforcing Hat section positioned in center of shelf, into clips and wedge shelf down in locked position.

FIGURE 23

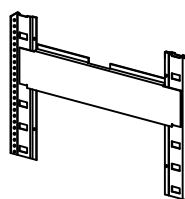
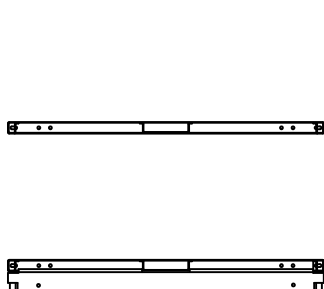

FIGURE 24



6. Class III Shelf Support Brace (#5136)

Insert shelf clips in post at desired location, then insert Class Three Shelf supports in slot below shelf clip in front and rear posts as shown in (Figure 24). Insert hat shaped Class II Center Support with flanges up against underside of shelf and under return flanges on side of shelf. Align with center of shelf and place on shelf clips. Be sure center tab on 5136 Shelf Support Brace is on outside of shelf and reinforcement is lined up with notch in support brace, then wedge shelf into clips (Figure 24).

FIGURE 25

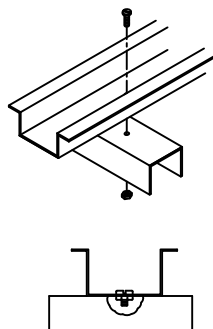

7. Bottom Shelf Class III

Bolt Class III Center Support Hat Section to bottom shelf support brace as shown in (Figure 25). Insert this assembly into shelf as described above. Place in unit on shelf clips and wedge shelf into clips. Part No. 5136 shelf support braces are not required.